



ELECTROSTATIC SENSITIVE DEVICE
OBSERVE HANDLING PRECAUTIONS

MITSUBISHI RF POWER MOS FET

RD07MVS1

RoHS Compliance, Silicon MOSFET Power Transistor, 175MHz, 520MHz, 7W

DESCRIPTION

RD07MVS1 is a MOS FET type transistor specifically designed for VHF/UHF RF power amplifiers applications.

FEATURES

High power gain:
 $P_{out} > 7W$, $G_p > 10dB @ V_{dd} = 7.2V, f = 520MHz$
 High Efficiency: 60%typ. (175MHz)
 High Efficiency: 55%typ. (520MHz)

APPLICATION

For output stage of high power amplifiers in VHF/UHF band mobile radio sets.

RoHS COMPLIANT

RD07MVS1-101, T112 is a RoHS compliant products.

RoHS compliance is indicate by the letter "G" after the Lot Marking.

This product include the lead in high melting temperature type solders.

How ever, it applicable to the following exceptions of RoHS Directions.

1. Lead in high melting temperature type solders (i.e. tin-lead solder alloys containing more than 85% lead.)

OUTLINE DRAWING

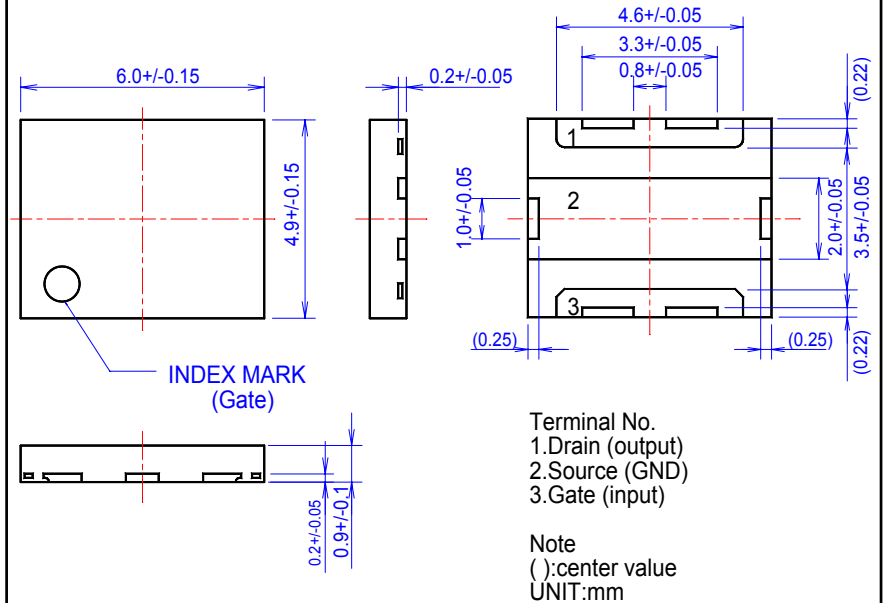

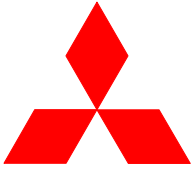

ELECTROSTATIC SENSITIVE DEVICE
OBSERVE HANDLING PRECAUTIONS

MITSUBISHI RF POWER MOS FET

RD07MVS1

RoHS Compliance, Silicon MOSFET Power Transistor, 175MHz, 520MHz, 7W

ABSOLUTE MAXIMUM RATINGS

(Tc=25°C UNLESS OTHERWISE NOTED)

SYMBOL	PARAMETER	CONDITIONS	RATINGS	UNIT
VDSS	Drain to source voltage	Vgs=0V	30	V
VGSS	Gate to source voltage	Vds=0V	+/- 20	V
Pch	Channel dissipation	Tc=25°C	50	W
Pin	Input Power	Zg=Zl=50Ω	1.5	W
ID	Drain Current	-	3	A
Tch	Junction Temperature	-	150	°C
Tstg	Storage temperature	-	-40 to +125	°C
Rth j-c	Thermal resistance	Junction to case	2.5	°C/W

Note 1: Above parameters are guaranteed independently.

ELECTRICAL CHARACTERISTICS (Tc=25°C, UNLESS OTHERWISE NOTED)

SYMBOL	PARAMETER	CONDITIONS	LIMITS			UNIT
			MIN	TYP	MAX.	
IDSS	Zero gate voltage drain current	VDS=17V, VGS=0V	-	-	200	uA
IGSS	Gate to source leak current	VGS=10V, VDS=0V	-	-	1	uA
VTH	Gate threshold Voltage	VDS=12V, IDS=1mA	1.4	1.7	2.4	V
Pout1	Output power	f=175MHz, VDD=7.2V	7	8	-	W
ηD1	Drain efficiency	Pin=0.3W, Idq=700mA	55	60	-	%
Pout2	Output power	f=520MHz, VDD=7.2V	7	8	-	W
ηD2	Drain efficiency	Pin=0.7W, Idq=750mA	50	55	-	%
	Load VSWR tolerance	VDD=9.2V, Po=7W(Pin Control) f=175MHz, Idq=700mA, Zg=50Ω Load VSWR=20:1(All Phase)	No destroy			-
	Load VSWR tolerance	VDD=9.2V, Po=7W(Pin Control) f=520MHz, Idq=750mA, Zg=50Ω Load VSWR=20:1(All Phase)	No destroy			-

Note : Above parameters , ratings , limits and conditions are subject to change.

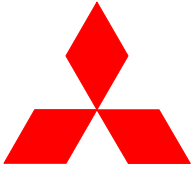

ELECTROSTATIC SENSITIVE DEVICE
OBSERVE HANDLING PRECAUTIONS

MITSUBISHI RF POWER MOS FET

RD07MVS1

RoHS Compliance, Silicon MOSFET Power Transistor, 175MHz, 520MHz, 7W

TYPICAL CHARACTERISTICS

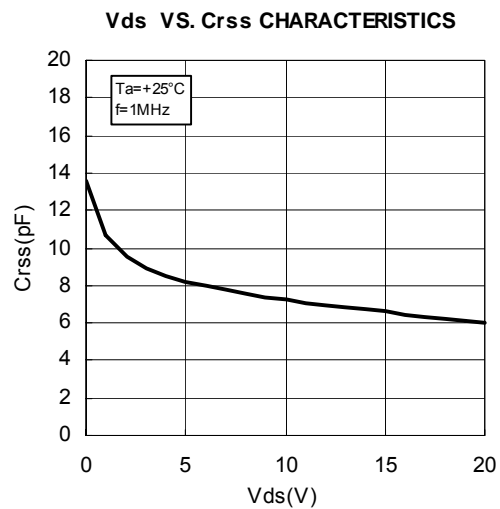
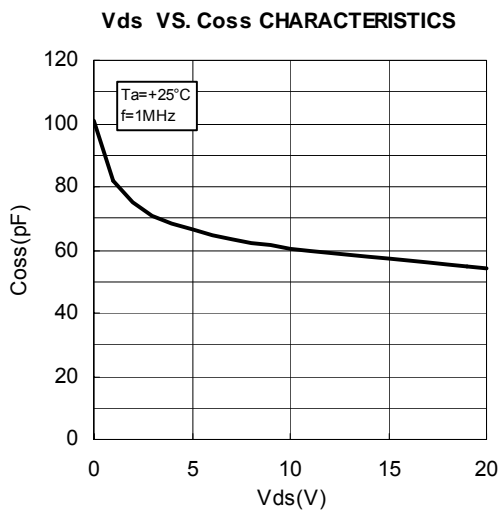
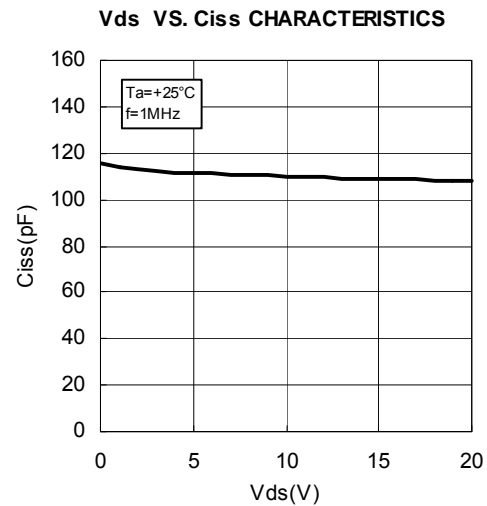
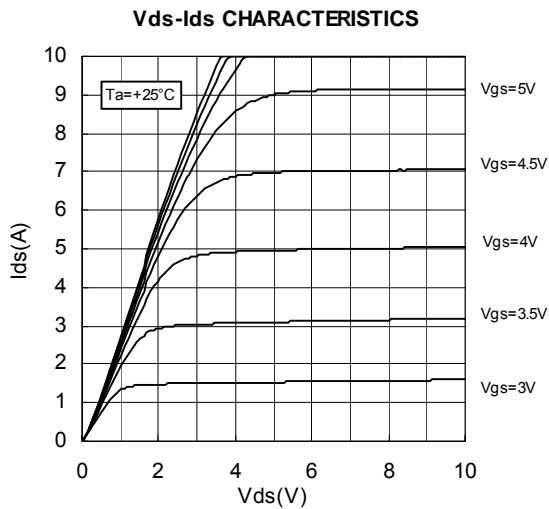
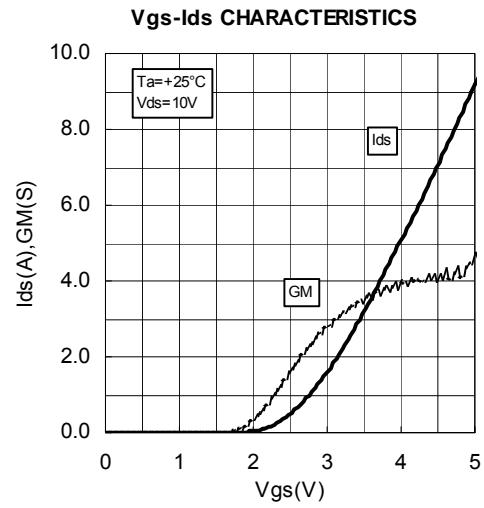
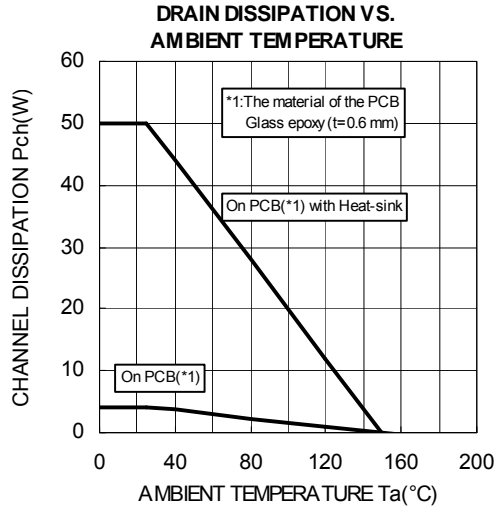

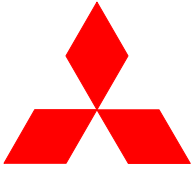

ELECTROSTATIC SENSITIVE DEVICE
OBSERVE HANDLING PRECAUTIONS

MITSUBISHI RF POWER MOS FET

RD07MVS1

RoHS Compliance, Silicon MOSFET Power Transistor, 175MHz, 520MHz, 7W

TYPICAL CHARACTERISTICS

Pin-Po CHARACTERISTICS
@f=175MHz

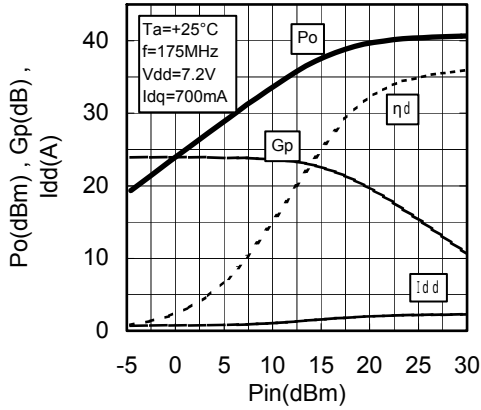

Pin-Po CHARACTERISTICS
@f=175MHz

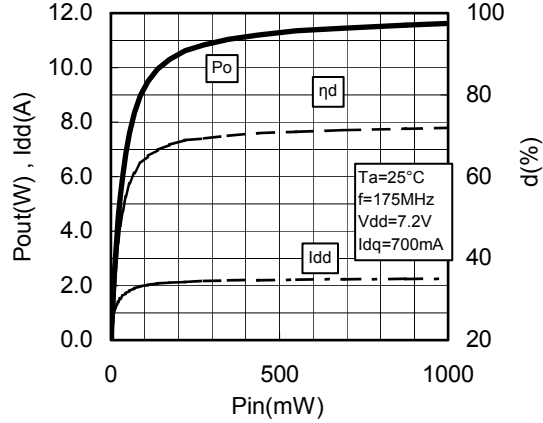

Pin-Po CHARACTERISTICS
@f=520MHz

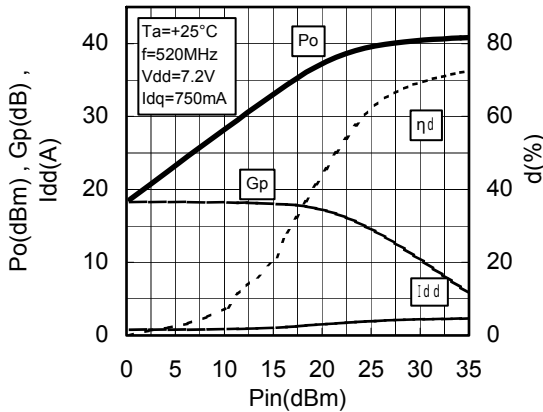

Pin-Po CHARACTERISTICS
@f=520MHz

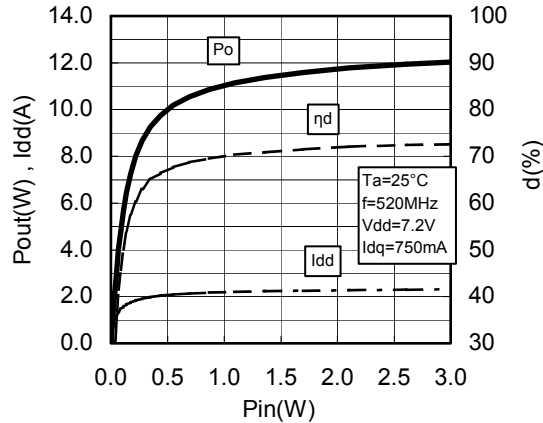

Vdd-Po CHARACTERISTICS
@f=175MHz

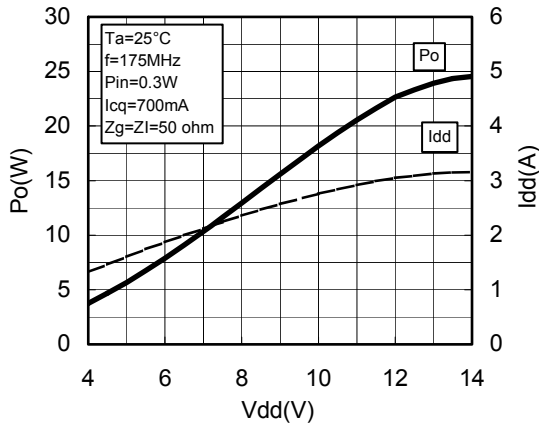

Vdd-Po CHARACTERISTICS
@f=520MHz

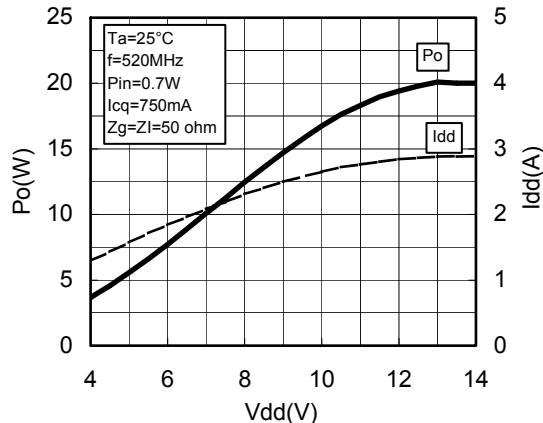

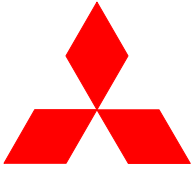

ELECTROSTATIC SENSITIVE DEVICE
OBSERVE HANDLING PRECAUTIONS

MITSUBISHI RF POWER MOS FET

RD07MVS1

RoHS Compliance, Silicon MOSFET Power Transistor, 175MHz, 520MHz, 7W

TYPICAL CHARACTERISTICS

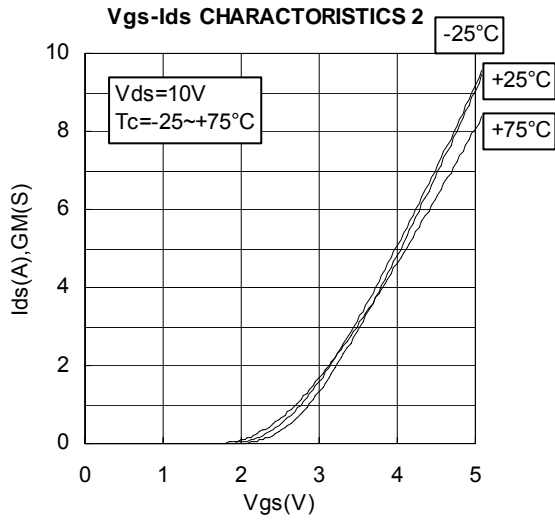



ELECTROSTATIC SENSITIVE DEVICE
OBSERVE HANDLING PRECAUTIONS

MITSUBISHI RF POWER MOS FET

RD07MVS1

RoHS Compliance, Silicon MOSFET Power Transistor, 175MHz, 520MHz, 7W

TEST CIRCUIT(f=175MHz)

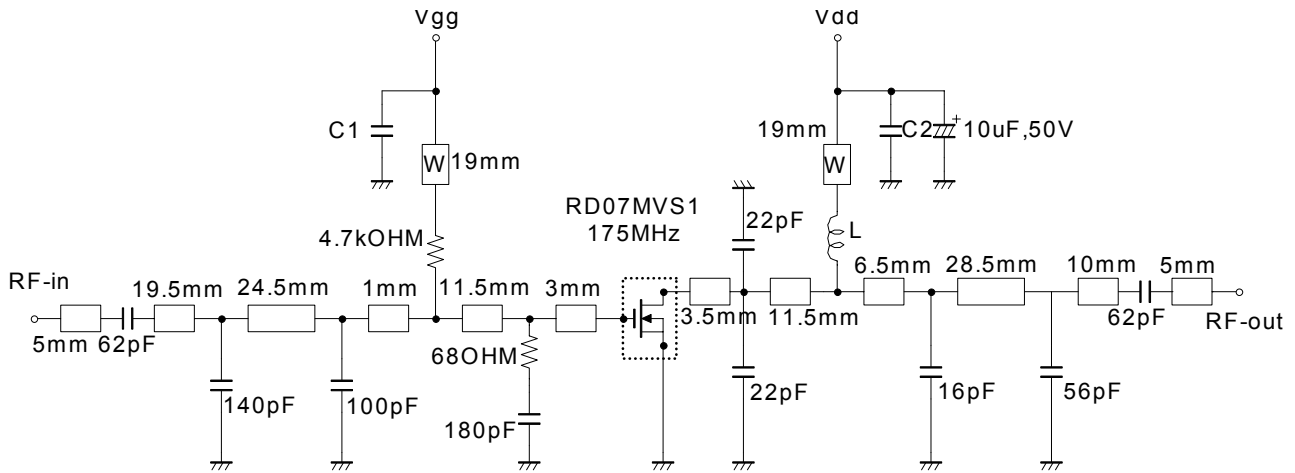

L: Enameled wire 7Turns, D:0.43mm, 2.46mm O.D
C1, C2: 1000pF, 0.022uF in parallel

Note: Board material- Teflon substrate
Micro strip line width=2.2mm/50OHM, er:2.7, t=0.8mm
W: line width=1.0mm

TEST CIRCUIT(f=520MHz)

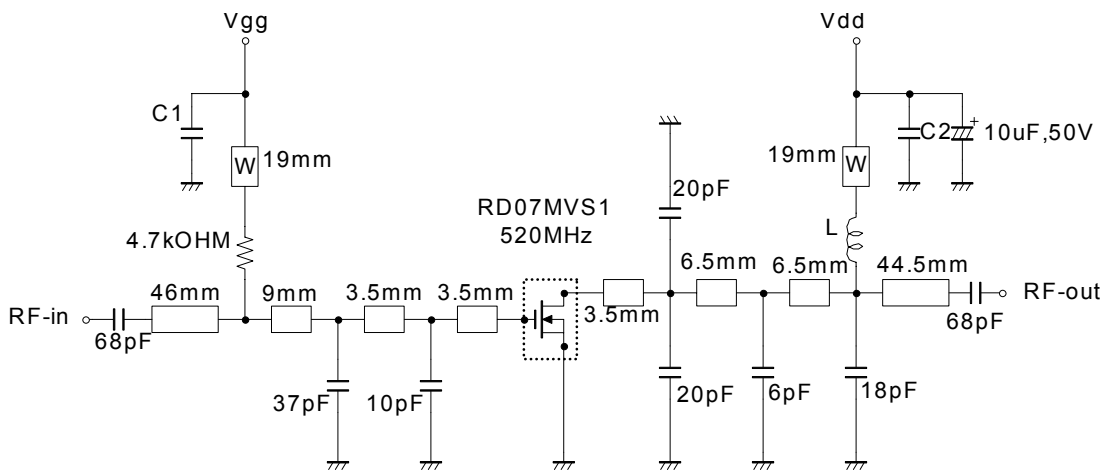

L: Enameled wire 5Turns, D:0.43mm, 2.46mm O.D
C1, C2: 1000pF, 0.022uF in parallel

Note: Board material- Teflon substrate
Micro strip line width=2.2mm/50OHM, er:2.7, t=0.8mm
W: line width=1.0mm



ELECTROSTATIC SENSITIVE DEVICE
OBSERVE HANDLING PRECAUTIONS

MITSUBISHI RF POWER MOS FET

RD07MVS1

RoHS Compliance, Silicon MOSFET Power Transistor, 175MHz, 520MHz, 7W

INPUT/OUTPUT IMPEDANCE VS. FREQUENCY CHARACTERISTICS

175MHz Z_{in}^* Z_{out}^*
 $Z_o=10\Omega$

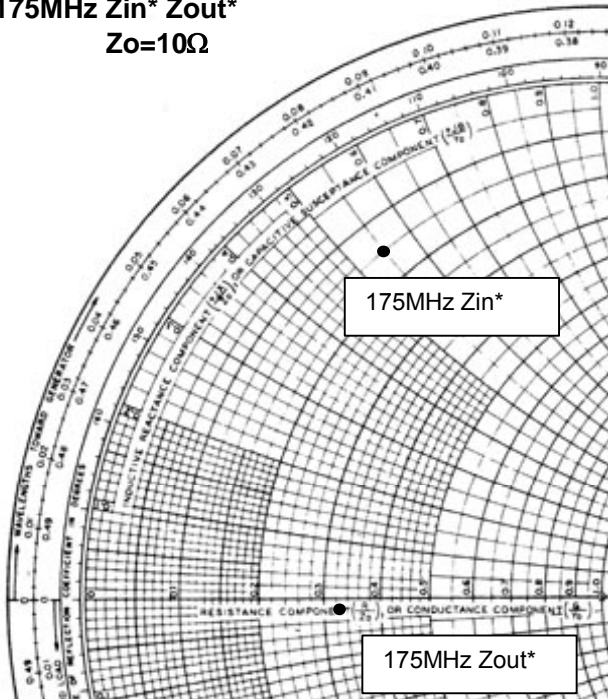

$V_{dd}=7.2V$, $I_{dq}=700mA$ (V_{gg} adj.), $P_{in}=0.28W$

$Z_{in}^*=1.55+j5.53$
 $Z_{out}^*=3.24-j0.26$

Z_{in}^* : Complex conjugate of input impedance
 Z_{out}^* : Complex conjugate of input impedance

520MHz Z_{in}^* Z_{out}^*
 $Z_o=10\Omega$

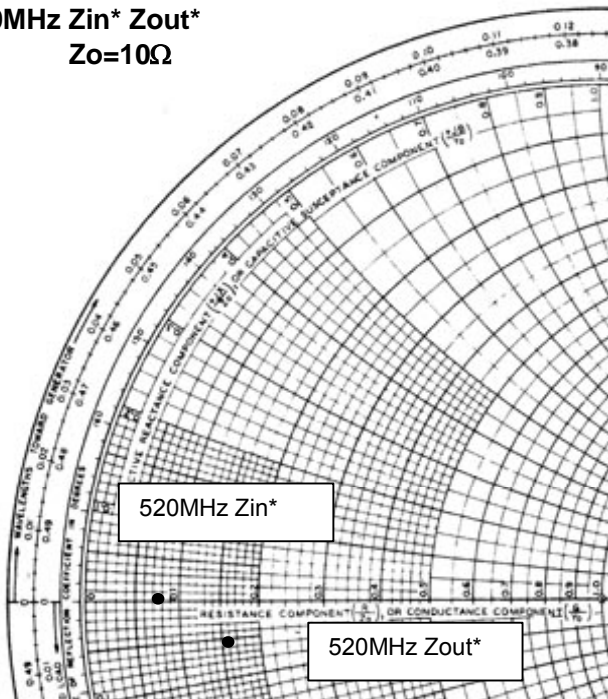

$V_{dd}=7.2V$, $I_{dq}=750mA$ (V_{gg} adj.), $P_{in}=0.7W$

$Z_{in}^*=0.76+j0.06$
 $Z_{out}^*=1.61-j0.52$

Z_{in}^* : Complex conjugate of input impedance
 Z_{out}^* : Complex conjugate of input impedance



ELECTROSTATIC SENSITIVE DEVICE
OBSERVE HANDLING PRECAUTIONS

MITSUBISHI RF POWER MOS FET

RD07MVS1

RoHS Compliance, Silicon MOSFET Power Transistor, 175MHz, 520MHz, 7W

RD07MVS1 S-PARAMETER DATA (@Vdd=7.2V, Id=750mA)

Freq. [MHz]	S11		S21		S12		S22	
	(mag)	(ang)	(mag)	(ang)	(mag)	(ang)	(mag)	(ang)
100	0.890	-174.1	5.508	82.1	0.016	-3.6	0.790	-172.8
150	0.897	-175.6	3.613	75.0	0.015	-8.5	0.801	-174.0
175	0.899	-176.0	3.028	72.4	0.015	-9.6	0.802	-174.1
200	0.901	-176.3	2.604	70.1	0.014	-10.9	0.815	-174.0
250	0.907	-176.7	2.019	65.6	0.014	-12.7	0.844	-174.1
300	0.913	-177.0	1.614	60.7	0.012	-15.3	0.843	-174.1
350	0.918	-177.3	1.308	57.1	0.011	-15.8	0.860	-174.4
400	0.924	-177.8	1.102	54.1	0.010	-14.2	0.879	-175.0
450	0.928	-178.0	0.929	50.1	0.009	-14.8	0.882	-175.1
500	0.933	-178.3	0.790	48.6	0.008	-9.6	0.895	-175.5
520	0.935	-178.5	0.753	47.6	0.007	-7.7	0.901	-175.8
550	0.937	-178.8	0.692	45.3	0.007	-5.6	0.906	-176.2
600	0.940	-179.2	0.595	43.6	0.006	0.4	0.907	-176.6
650	0.942	-179.4	0.529	42.4	0.006	17.1	0.916	-177.2
700	0.944	-179.8	0.467	40.2	0.005	21.8	0.923	-177.6
750	0.947	179.8	0.416	39.4	0.005	40.9	0.921	-178.0
800	0.948	179.4	0.374	38.6	0.004	52.0	0.930	-178.8
850	0.949	179.0	0.343	37.6	0.005	67.1	0.933	-178.9
900	0.951	178.6	0.304	36.5	0.005	72.6	0.932	-179.3
950	0.951	178.2	0.284	37.6	0.006	85.8	0.937	179.8
1000	0.952	177.9	0.262	35.1	0.007	85.1	0.938	179.7
1050	0.950	177.4	0.234	36.0	0.008	89.8	0.938	179.3
1100	0.952	176.9	0.226	35.8	0.009	93.4	0.940	178.2

RD07MVS1 S-PARAMETER DATA (@Vdd=12.5V, Id=750mA)

Freq. [MHz]	S11		S21		S12		S22	
	(mag)	(ang)	(mag)	(ang)	(mag)	(ang)	(mag)	(ang)
100	0.883	-172.1	6.013	81.0	0.017	-5.3	0.748	-170.4
150	0.891	-174.1	3.914	72.8	0.016	-10.7	0.765	-171.4
175	0.894	-174.6	3.269	69.8	0.016	-13.1	0.769	-171.4
200	0.897	-175.0	2.798	67.2	0.015	-14.9	0.786	-171.3
250	0.906	-175.6	2.144	62.1	0.014	-18.3	0.822	-171.4
300	0.914	-176.0	1.697	56.9	0.012	-20.4	0.828	-171.6
350	0.920	-176.4	1.361	53.0	0.011	-21.6	0.848	-172.0
400	0.927	-177.0	1.134	49.9	0.010	-21.2	0.871	-172.9
450	0.932	-177.4	0.949	45.8	0.009	-21.8	0.876	-173.2
500	0.937	-177.8	0.800	44.2	0.007	-16.9	0.892	-173.7
520	0.938	-178.0	0.761	43.2	0.007	-16.0	0.898	-174.1
550	0.940	-178.3	0.697	41.1	0.006	-13.3	0.904	-174.6
600	0.944	-178.8	0.594	39.3	0.005	-7.2	0.906	-175.1
650	0.946	-179.1	0.527	38.2	0.004	4.5	0.917	-175.9
700	0.948	-179.5	0.464	36.1	0.004	17.4	0.924	-176.3
750	0.950	-179.9	0.412	35.5	0.004	28.0	0.922	-176.9
800	0.951	179.6	0.368	34.5	0.004	56.9	0.931	-177.8
850	0.953	179.2	0.336	33.6	0.004	66.4	0.934	-178.0
900	0.954	178.8	0.297	32.3	0.005	78.3	0.933	-178.3
950	0.954	178.4	0.276	33.8	0.006	87.4	0.939	-179.4
1000	0.954	178.0	0.254	31.1	0.006	90.9	0.941	-179.5
1050	0.952	177.5	0.226	32.2	0.007	94.7	0.940	-179.9
1100	0.954	177.0	0.219	32.0	0.008	98.0	0.943	178.9

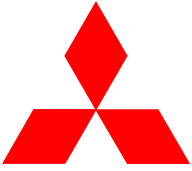

ELECTROSTATIC SENSITIVE DEVICE
OBSERVE HANDLING PRECAUTIONS

MITSUBISHI RF POWER MOS FET

RD07MVS1

RoHS Compliance, Silicon MOSFET Power Transistor, 175MHz, 520MHz, 7W

—Keep safety first in your circuit designs! —

Mitsubishi Electric Corporation puts the maximum effort into making semiconductor products better and more reliable, but there is always the possibility that trouble may occur with them. Trouble with semiconductors may lead to personal injury, fire or property damage. Remember to give due consideration to safety when making your circuit designs, with appropriate measures such as (i) placement of substitutive, auxiliary circuits, (ii) use of non-flammable material or (iii) prevention against any malfunction or mishap.

warning !

Do not use the device at the exceeded the maximum rating condition. In case of plastic molded devices, the exceeded maximum rating condition may cause blowout, smoldering or catch fire of the molding resin due to extreme short current flow between the drain and the source of the device. These results causes in fire or injury.