



Cascadable Silicon Bipolar MMIC Amplifier

Technical Data

MSA-1105

Features

- **High Dynamic Range**
Cascadable $50\ \Omega$ or $75\ \Omega$
Gain Block
- **3 dB Bandwidth:**
50 MHz to 1.3 GHz
- **17.5 dBm Typical $P_{1\text{ dB}}$ at 0.5 GHz**
- **3.6 dB Typical Noise Figure at 0.5 GHz**
- **Surface Mount Plastic Package**
- **Tape-and-Reel Packaging Option Available⁽¹⁾**

Note:

1. Refer to PACKAGING section "Tape-and-Reel Packaging for Semiconductor Devices."

Description

The MSA-1105 is a high performance silicon bipolar Monolithic Microwave Integrated Circuit (MMIC) housed in a low cost, surface mount plastic package. This MMIC is designed for high dynamic range in either $50\ \Omega$ or $75\ \Omega$ systems by combining low noise figure with high IP_3 . Typical applications include narrow and broadband linear amplifiers in commercial and industrial systems.

The MSA-series is fabricated using Agilent's 10 GHz f_T , 25 GHz f_{MAX} silicon bipolar MMIC process which uses nitride self-alignment, ion implantation, and gold metallization to achieve excellent performance, uniformity and reliability. The use of an external bias resistor for temperature and current stability also allows bias flexibility.

05 Plastic Package

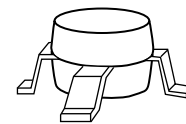

Typical Biasing Configuration

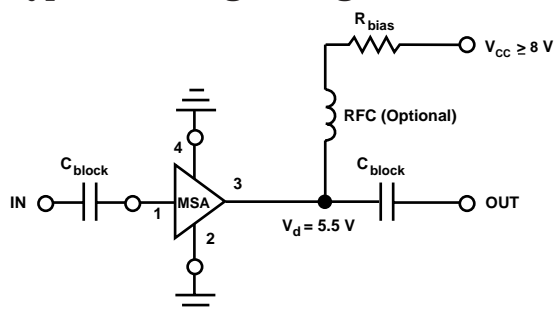

MSA-1105 Absolute Maximum Ratings

| Parameter | Absolute Maximum ^[1] |
|------------------------------------|---------------------------------|
| Device Current | 80 mA |
| Power Dissipation ^[2,3] | 550 mW |
| RF Input Power | +13 dBm |
| Junction Temperature | 150°C |
| Storage Temperature | -65 to 150°C |

Thermal Resistance^[2,4]:

$$\theta_{jc} = 125^{\circ}\text{C/W}$$

Notes:

1. Permanent damage may occur if any of these limits are exceeded.
2. $T_{\text{CASE}} = 25^{\circ}\text{C}$.
3. Derate at $8 \text{ mW}/^{\circ}\text{C}$ for $T_{\text{C}} > 124^{\circ}\text{C}$.
4. See MEASUREMENTS section "Thermal Resistance" for more information.

Electrical Specifications^[1], $T_{\text{A}} = 25^{\circ}\text{C}$

| Symbol | Parameters and Test Conditions: $I_{\text{d}} = 60 \text{ mA}$, $Z_{\text{o}} = 50 \Omega$ | Units | Min. | Typ. | Max. | |
|-----------------------|---|---------------------------------------|------------------------------|------|-----------|------|
| G_{P} | Power Gain ($ S_{21} ^2$) | $f = 0.05 \text{ GHz}$ | dB | 10.0 | 12.7 | |
| | | $f = 0.5 \text{ GHz}$ | | | | 12.0 |
| | | $f = 1.0 \text{ GHz}$ | | | | 10.5 |
| ΔG_{P} | Gain Flatness | $f = 0.1 \text{ to } 1.0 \text{ GHz}$ | dB | | ± 1.0 | |
| $f_{3 \text{ dB}}$ | 3 dB Bandwidth ^[2] | | GHz | | 1.3 | |
| VSWR | Input VSWR | $f = 0.1 \text{ to } 1.0 \text{ GHz}$ | | | 1.5:1 | |
| | Output VSWR | $f = 0.1 \text{ to } 1.0 \text{ GHz}$ | | | 1.7:1 | |
| NF | 50 Ω Noise Figure | $f = 0.5 \text{ GHz}$ | dB | | 3.6 | |
| $P_{1 \text{ dB}}$ | Output Power at 1 dB Gain Compression | $f = 0.5 \text{ GHz}$ | dBm | | 17.5 | |
| IP_3 | Third Order Intercept Point | $f = 0.5 \text{ GHz}$ | dBm | | 30.0 | |
| t_{D} | Group Delay | $f = 0.5 \text{ GHz}$ | psec | | 200 | |
| V_{d} | Device Voltage | | V | 4.4 | 5.5 | 6.6 |
| dV/dT | Device Voltage Temperature Coefficient | | $\text{mV}/^{\circ}\text{C}$ | | -8.0 | |

Notes:

1. The recommended operating current range for this device is 40 to 70 mA. Typical performance as a function of current is on the following page.
2. Referenced from 50 MHz gain (G_{P}).

Part Number Ordering Information

| Part Number | No. of Devices | Container |
|--------------|----------------|----------------|
| MSA-1105-TR1 | 500 | 7" Reel |
| MSA-1105-STR | 10 | Antistatic Bag |

For more information, see "Tape and Reel Packaging for Semiconductor Devices".

MSA-1105 Typical Scattering Parameters ($Z_0 = 50 \Omega$, $T_A = 25^\circ\text{C}$, $I_d = 60 \text{ mA}$)

| Freq. GHz | S_{11} | | S_{21} | | | S_{12} | | | S_{22} | | k |
|--------------|----------|------|----------|------|-----|----------|------|-----|----------|------|------|
| | Mag | Ang | dB | Mag | Ang | dB | Mag | Ang | Mag | Ang | |
| .0005 | .80 | -17 | 19.0 | 8.94 | 171 | -26.0 | .050 | 51 | .81 | -16 | 0.53 |
| .005 | .26 | -62 | 13.9 | 4.98 | 163 | -16.8 | .144 | 15 | .26 | -64 | 0.93 |
| .025 | .07 | -48 | 12.8 | 4.36 | 174 | -16.4 | .151 | 4 | .08 | -52 | 1.08 |
| .050 | .06 | -38 | 12.7 | 4.33 | 174 | -16.3 | .153 | 2 | .06 | -48 | 1.08 |
| .100 | .05 | -41 | 12.7 | 4.31 | 170 | -16.4 | .152 | 3 | .06 | -52 | 1.09 |
| .200 | .06 | -58 | 12.6 | 4.26 | 162 | -16.2 | .155 | 5 | .08 | -73 | 1.08 |
| .300 | .07 | -74 | 12.4 | 4.19 | 154 | -16.1 | .157 | 7 | .10 | -91 | 1.07 |
| .400 | .09 | -91 | 12.2 | 4.10 | 146 | -15.8 | .163 | 8 | .12 | -105 | 1.06 |
| .500 | .10 | -105 | 12.0 | 4.00 | 138 | -15.6 | .166 | 8 | .14 | -116 | 1.05 |
| .600 | .11 | -116 | 11.8 | 3.88 | 131 | -15.4 | .171 | 10 | .17 | -126 | 1.04 |
| .700 | .13 | -128 | 11.5 | 3.76 | 123 | -15.0 | .178 | 11 | .18 | -135 | 1.03 |
| .800 | .15 | -136 | 11.2 | 3.63 | 116 | -14.7 | .184 | 11 | .21 | -144 | 1.01 |
| .900 | .16 | -145 | 10.9 | 3.49 | 109 | -15.5 | .188 | 11 | .22 | -151 | 1.01 |
| 1.000 | .18 | -152 | 10.5 | 3.37 | 102 | -14.1 | .197 | 11 | .24 | -159 | 1.00 |
| 1.500 | .28 | 174 | 8.8 | 2.75 | 72 | -13.2 | .219 | 7 | .31 | 170 | 1.00 |
| 2.000 | .38 | 150 | 7.1 | 2.28 | 48 | -12.1 | .248 | 0 | .34 | 151 | 0.99 |
| 2.500 | .46 | 133 | 5.6 | 1.90 | 28 | -11.9 | .254 | -4 | .38 | 134 | 1.02 |
| 3.000 | .53 | 118 | 4.2 | 1.62 | 11 | -11.6 | .262 | -8 | .40 | 122 | 1.04 |

A model for this device is available in the DEVICE MODELS section.

Typical Performance, $T_A = 25^\circ\text{C}$, $Z_0 = 50 \Omega$

(unless otherwise noted)

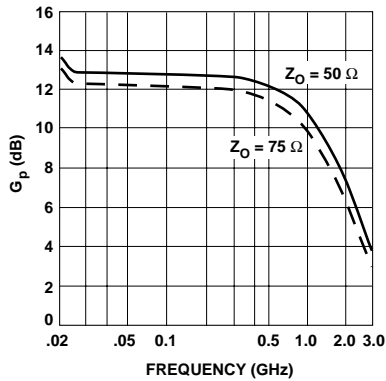

Figure 1. Typical Power Gain vs. Frequency, $I_d = 60 \text{ mA}$.

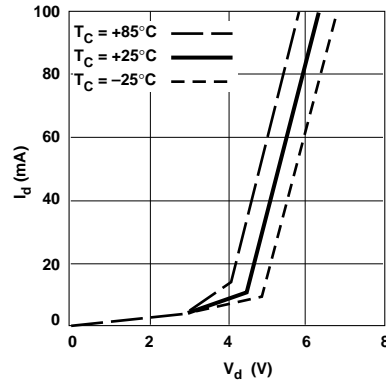

Figure 2. Device Current vs. Voltage.

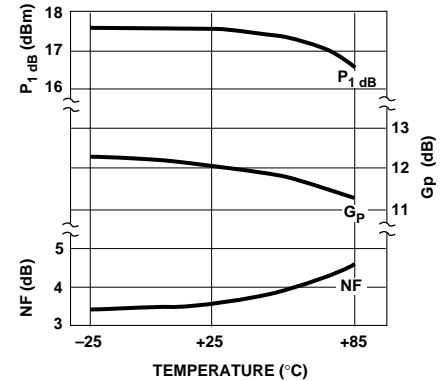

Figure 3. Output Power at 1 dB Gain Compression, Noise Figure and Power Gain vs. Case Temperature, $f = 0.5 \text{ GHz}$, $I_d = 60 \text{ mA}$.

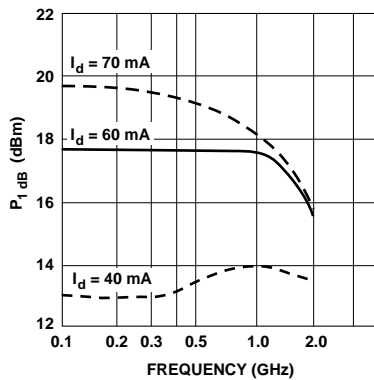

Figure 4. Output Power at 1 dB Gain Compression vs. Frequency.

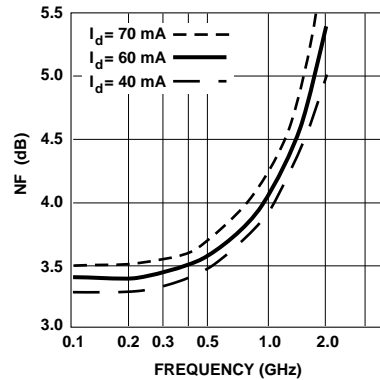
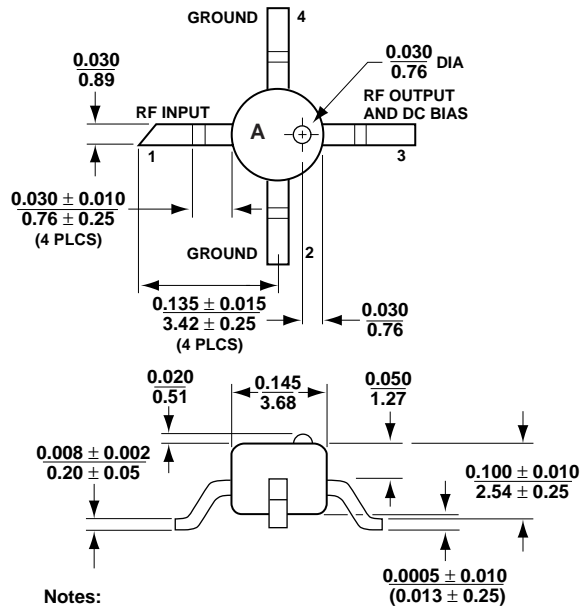

Figure 5. Noise Figure vs. Frequency.



05 Plastic Package Dimensions



Notes:

(unless otherwise specified)

1. Dimensions are $\frac{\text{in}}{\text{mm}}$
2. Tolerances
in .xxx = ± 0.005
mm .xx = ± 0.13